

N : \_\_\_\_\_-357-(GK)  
C : \_\_\_\_\_  
D : \_\_\_\_\_

### 一级代理商：

深圳市弗瑞鑫电子有限公司

地址：深圳市宝安区西乡大道302号金源商务大厦B座三楼

frxelec

- (1) Current transfer ratio (CTR : MIN. 50% at  $I_F = 5\text{mA}$ ,  $V_{CE} = 5\text{V}$ ,  $T_a = 25^\circ\text{C}$ )
- (2) High input impedance (VISO=3,750Vrms)
- (3) High collector-emitter voltage ( $V_{CEO} = 80\text{V}$ )
- (4) 4 pin package
- (5) Storage temperature range from -55 to 125
- (6) Output power (M 8000, 2000V)
- (7) MSL C (IPC 19001231256)
- (8) In compliance with RoHS, Lead free
- (9) MSL C (IPC 19001231256)



- OR-357-(GK) 4
- OR-357-(GK) 2.54

- (1) H
- (2)
- (3)

**Functional Diagram**

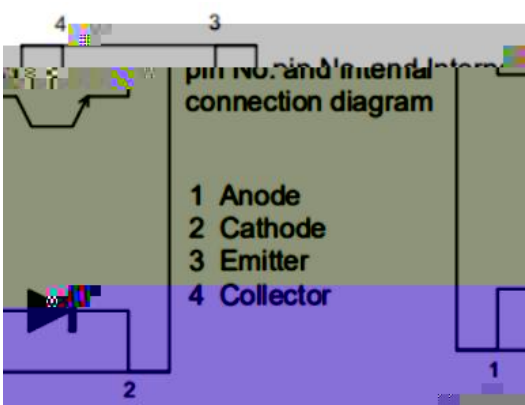

°C

I	F C	I <sub>F</sub>	50	A
	J	J	125	°C
			6	
	C		70	
I	C	CE	80	
	E	EC	7	
	C C	I <sub>C</sub>	50	A
	C	c	150	
	C		200	
	*1 I		3750	
			-55 + 125	°C
	D		-55 + 150	
	*2		260	

\*1. AC, 1, = 40 60%

I :

(1)

(2) N C

(3) A

\*2. 10

I	F	F	---	1.2	1.4		$I_F=20 \text{ A}$	
	C	I	---	---	5	A	$=5$	
	C	C	---	30	250	F	$=0, =1\text{KH}$	
I	C	C	$I_{CE}$	---	---	100	A $I_{CE}=20, I_F=0 \text{ A}$	
	C	E	$B_{CE}$	80	---	---	$I_C=0.1 \text{ A}$ $I_F=0 \text{ A}$	
	E	C	$B_{EC}$	7	---	---	$I_E=0.1 \text{ A}$ $I_F=0 \text{ A}$	
C	*1.C	C		50	---	600	% $I_F=5 \text{ A}$ $I_{CE}=5$	
	C	C	$I_C$	2.5	---	30	A	
	C	E	$I_{CE}(\ )$	---	---	0.2	$I_F=20 \text{ A}$ $I_C=1 \text{ A}$	
	I	I		$5 \cdot 10^{10}$	$1 \cdot 10^{11}$	---	DC500 40 60% .H.	
	F	C	C	---	0.6	1	F $=0, =1\text{MH}$	
					---	2.9	10	$I_{CC}=2, I_C=2 \text{ A}, I_L=100$
	D				---	4.5	10	

● C C =  $I_C / I_F$  100%



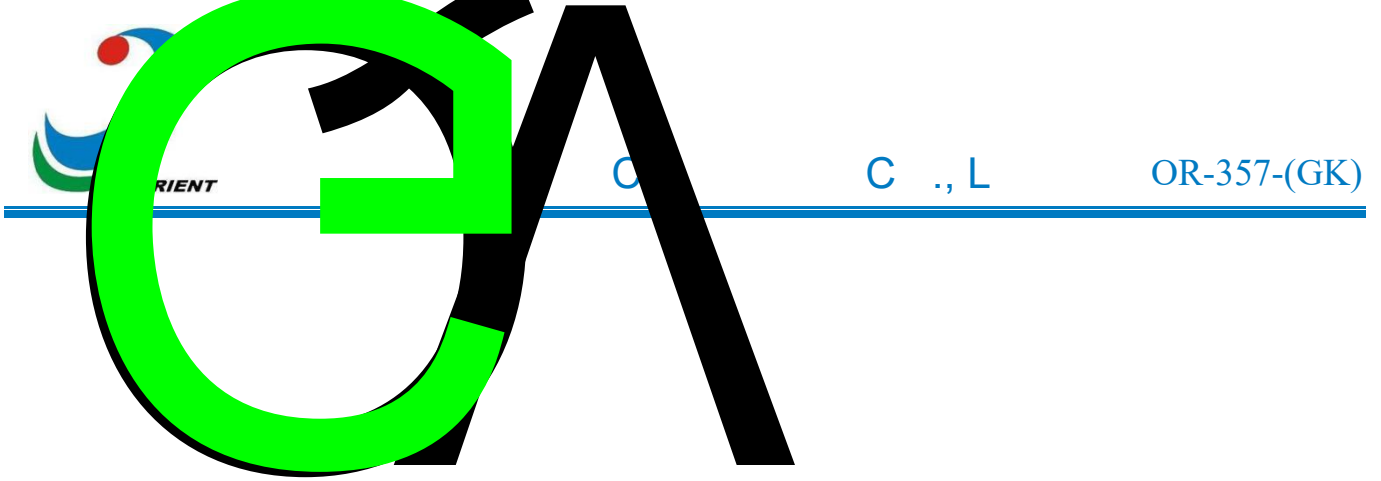

1. Man fac er : ORIENT.
2. Par N mber : 357.
3. Rank Code  : CTR Rank
4. Year Code  : '0' mean '2020' and o on.
5. Week Code  : 01 mean he fir eek, 02 mean he econd eek and o on.
6. VDE Code

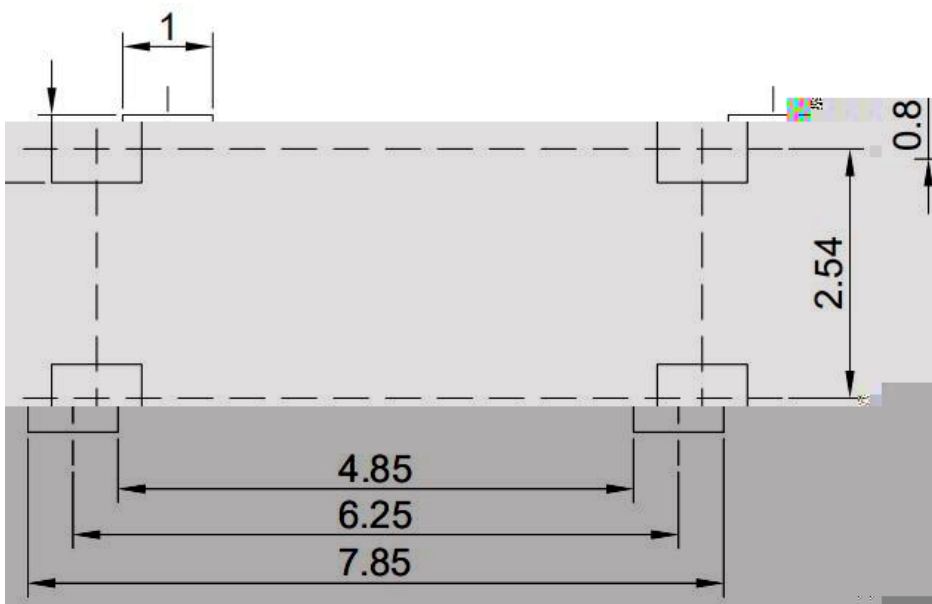
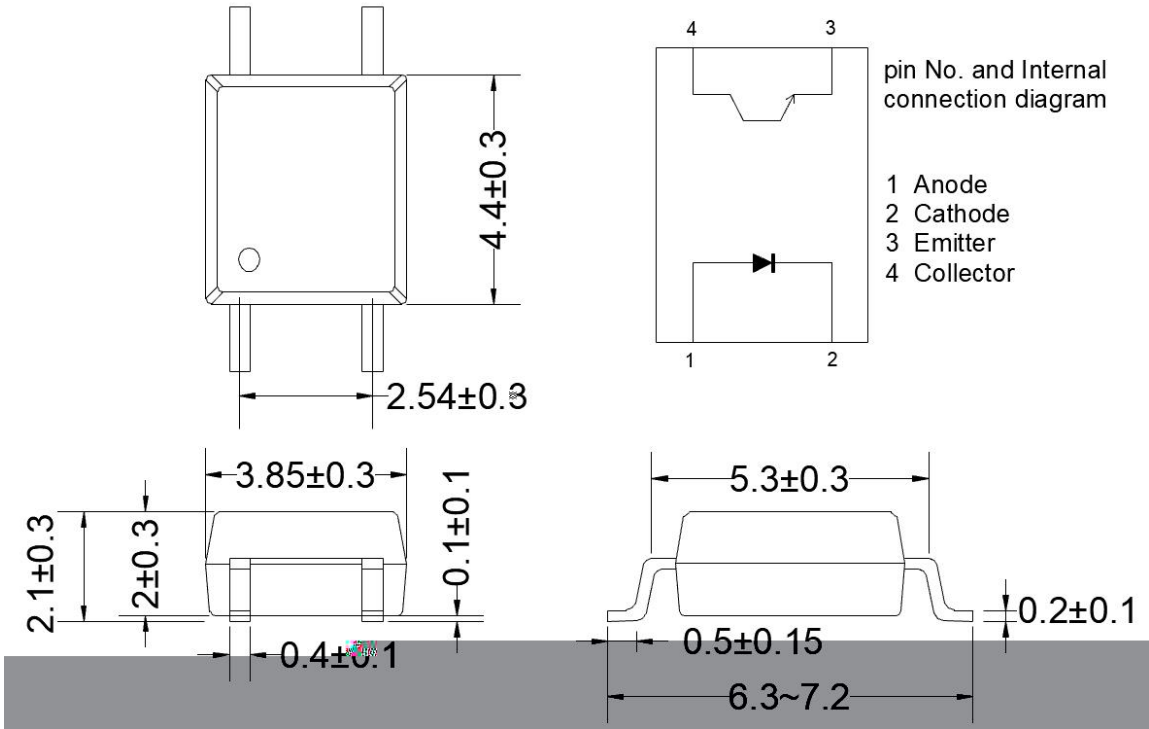

:

( )

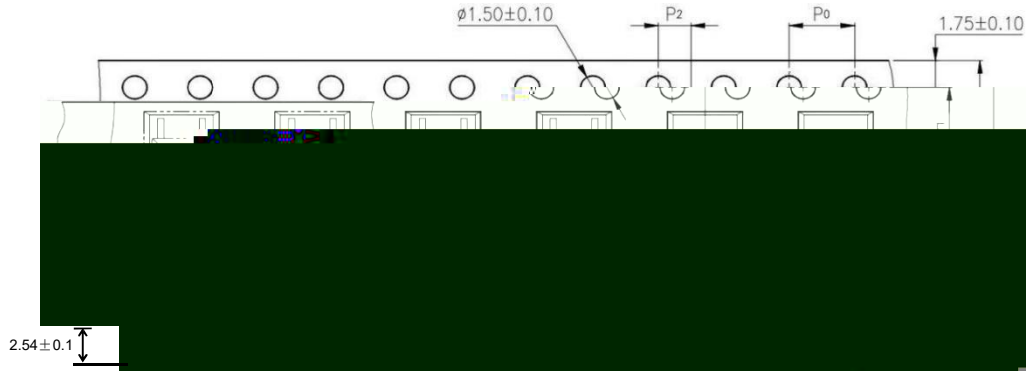

( )

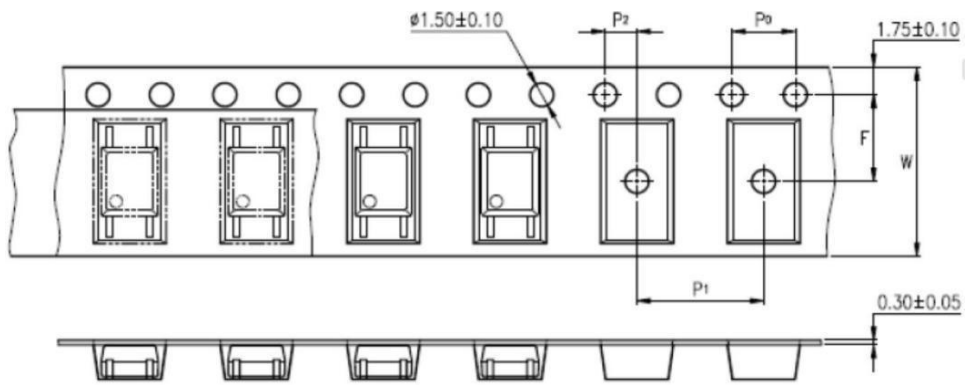

		12 0.3 (0.472)
	0	4 0.1 (0.157)
D	F	5.5 0.1 (0.217)
	2	2 0.1 (0.079)
D	1	8 0.1 (0.315)

( )	3000





C

C ., L

OR-357-(GK)

---

NO.	ITEMS	Reliability Testing				
		QTY. (Pcs)	Condition	Process	Device	Standard
1	RSH 耐焊接热	22	260±5℃	10 /3 次	锡炉	JESD22-A106
2	HTSL 高温存储	77	125℃	168 hr	高温烤箱 测试仪	JESD22-A103
				500 hr		
				1000 hr		
3	LTSL 低温存储	77	-55℃	168 hr	低温箱 测试仪	JESD22-A119
				500 hr		
				1000 hr		
4	TC 温度循环	77	H:125℃ 15min ∫ 5min L:-55℃ 15min	300 c cle	冷热冲击机	JESD22-A104
5	TS 温度冲击	77	H:100℃ 5min ∫ 15 L:-40℃ 5min	300 c cle	冷热冲击机	JESD22-A106
6	HTOL 高温操作	77	110 C IF=10mA Vce=5V	168 hr	高温烤箱 测试仪、老 化电路板	JESD22-A108
				500 hr		
				1000 hr		
7	ESD-HBM 人体模式	22	≥8KV 1C cle	1次	ESD静电测 试仪	JESD22-A114
8	SD 可焊性	22	Pb-free 245±5℃	5S/1次	锡炉	JESD22-B102
9	HTRB 高温反向偏压	77	HTRB @125℃ Vce=80	168 hr	高温烤箱 , 测试仪	JESD22-A103
				500 hr		
				1000 hr		
10	H3TRB 温湿度反向偏 压, 寿命试验	77	H3TRB 85℃,85%RH Vce=80	168 hr	恒温恒湿 机, 测试仪	JESD22-A101
				500 hr		
				1000 hr		
11	Autoclave 压力锅	77	Ta=121 ℃,100%RH,2a m	96hr	压力锅	JESD22-A102

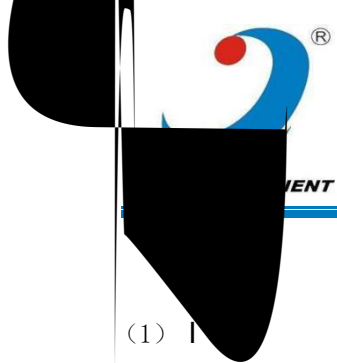

(1) ( JEDEC- D-020C )

.D

- M ( )	150 C
- M ( )	200 C
- ( ) ( )	90 30
- ( L )	217 C
- ( L )	60
	260 C
	20
-	3 C /
-	3 6 C /
	≤3

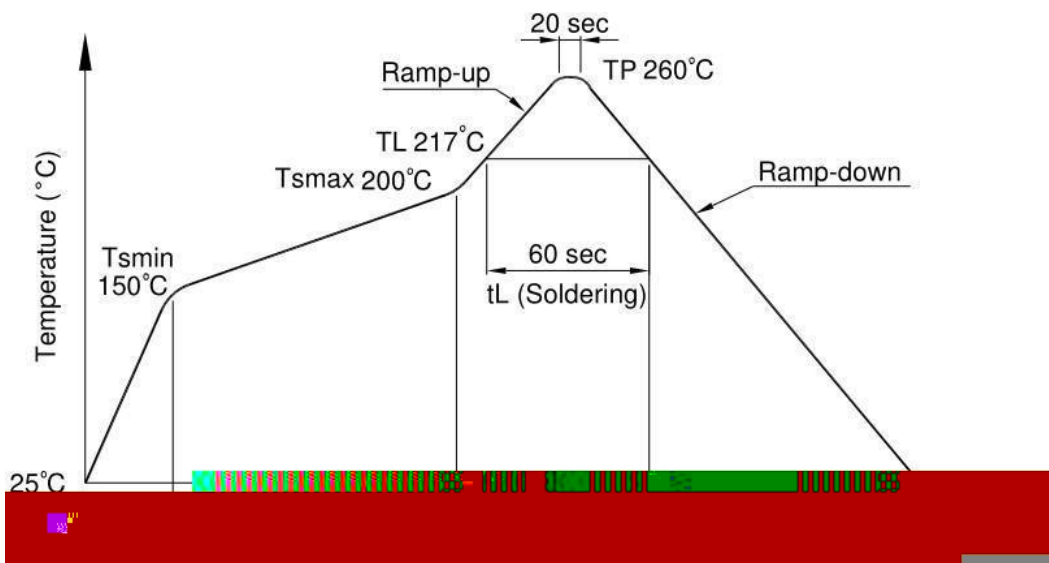



C

C ., L

OR-357-(GK)

---

### Characteristics Curves

Fig.1 Forward current vs Ambient temperature

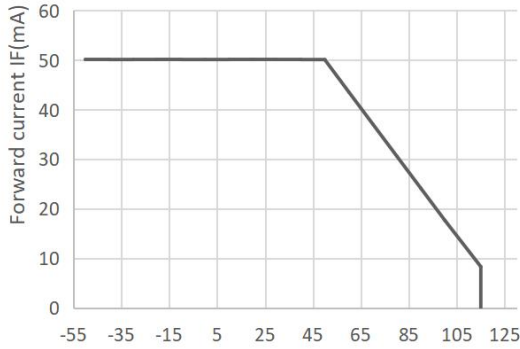

Fig.2 Collector Power Dissipation vs. Ambient temperature

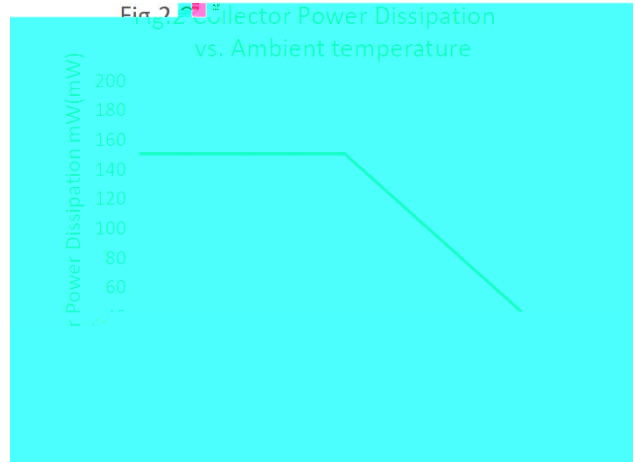

Fig.3 Collector-emitter Saturation Voltage

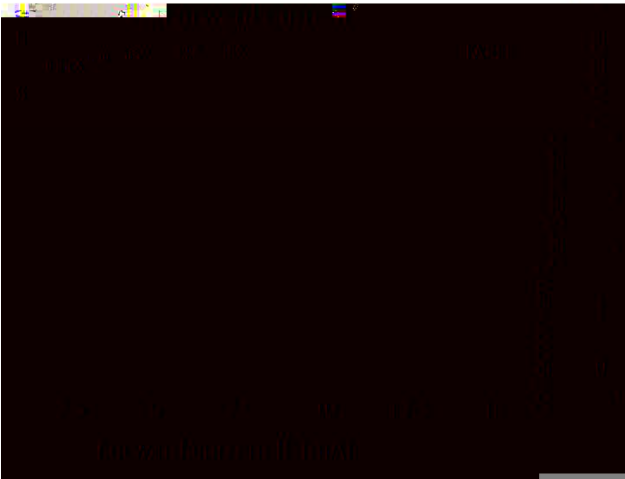

Fig.4 Forward Current vs. Forward Voltage

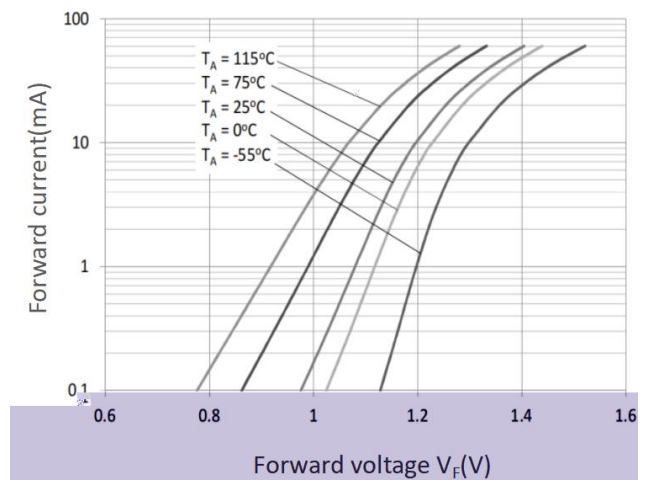

Fig.5 Forward Current vs. Current Transfer Ratio

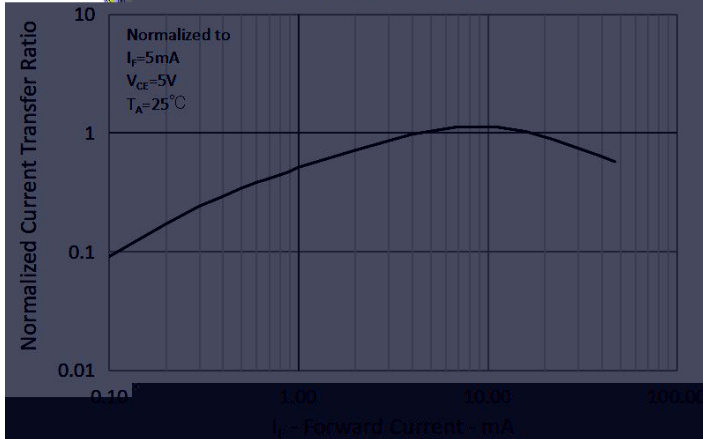

Fig.6 Collector Current vs. Collector-emitter Voltage

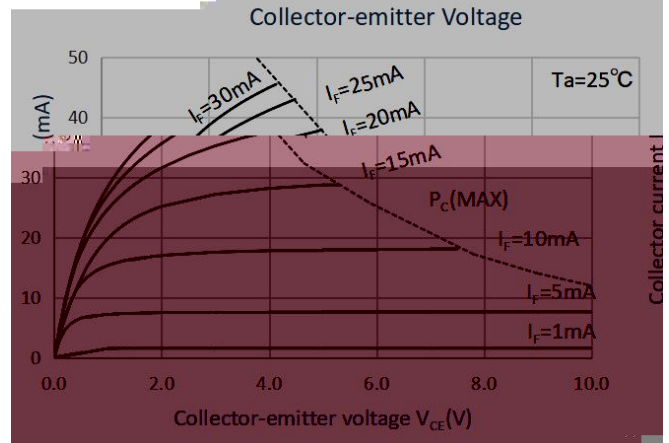

Fig.7 Relative Current Transfer Ratio vs. Ambient Temperature

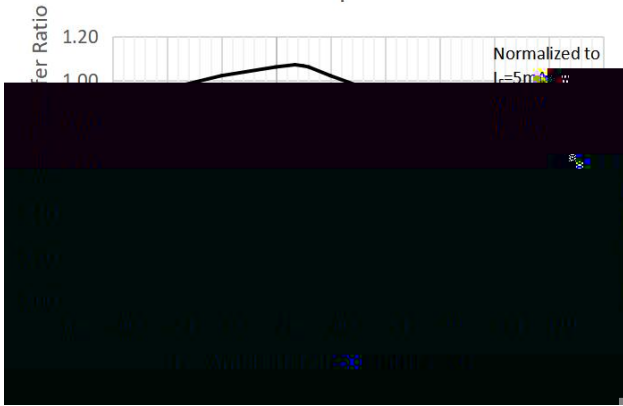

Fig.8 Collector-emitter Saturation Voltage vs. Ambient Temperature

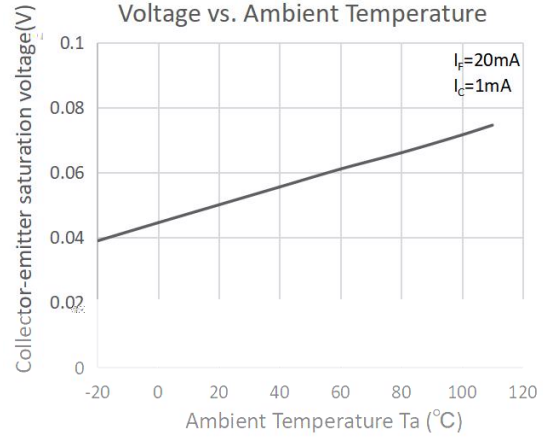

Fig.9 Collector Dark Current vs. Ambient Temperature

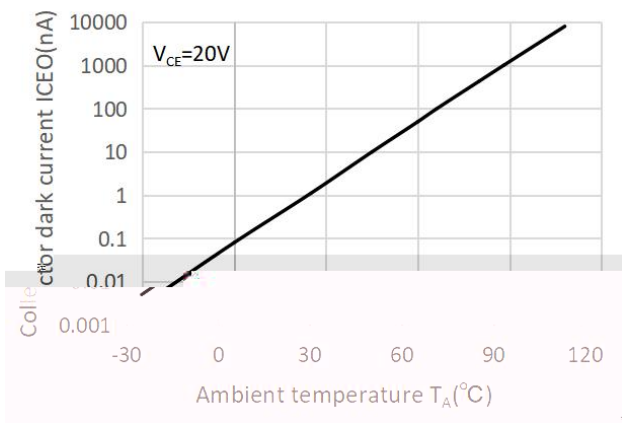

Fig.10 Respsine Time vs. Load Resistance

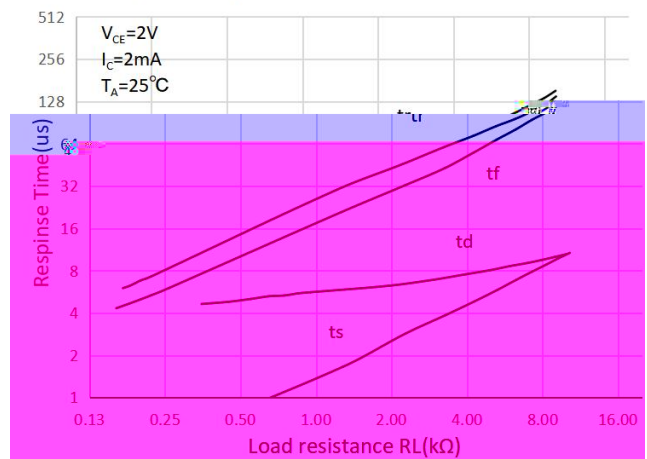
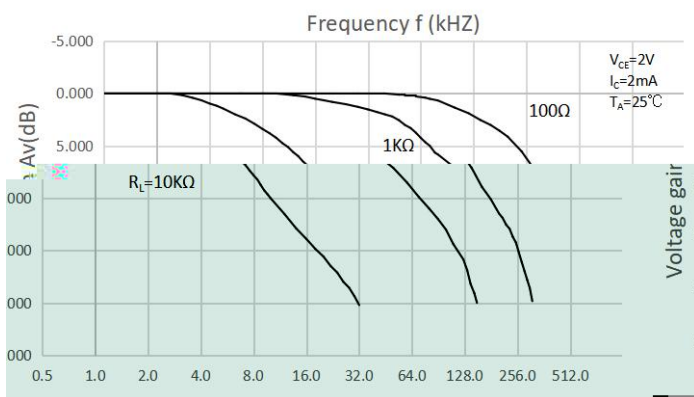
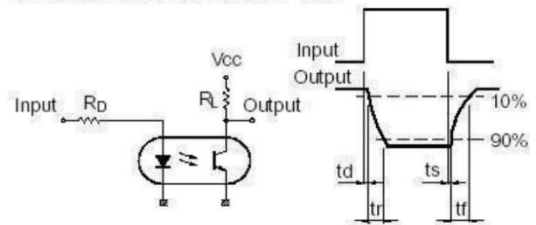

Fig.11 Frequency Response



Test Circuit for Response Time



Test Circuit for Frequency Response

