

# 深圳市弗瑞鑫电子有限公司

## 规格承认书

—

\_\_\_\_\_

\_\_\_\_\_

prepare	
check	
approve	



TRX电容一级代理商

深圳市弗瑞鑫电子有限公司

Add: 深圳市宝安区西乡大道302号金源商务大厦B座3楼

Tel: 0755-29563634

Fax: 0755-27447020

- 2

2 . .

/

/

/

/



- 2 2 . .			
/		/	
/		/	

	- 2 2 . .		
	/		/
	/		/

1. /

$\overline{\text{①}}$   $\overline{\text{②}}$   $\overline{\text{③}}$   $\overline{\text{④}}$   $\overline{\text{⑤}}$   $\overline{\text{⑥}}$

①

	- 2 2 . .		
	/		/
	/		/

3. /



4. /

5. /

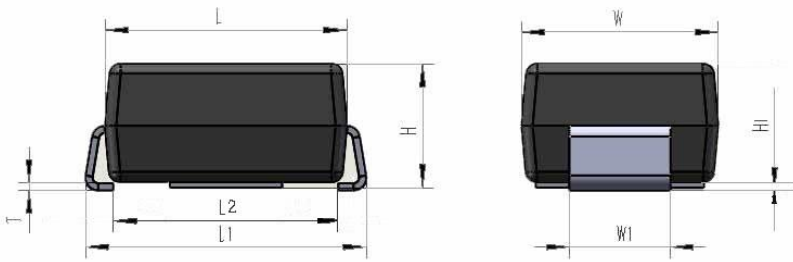

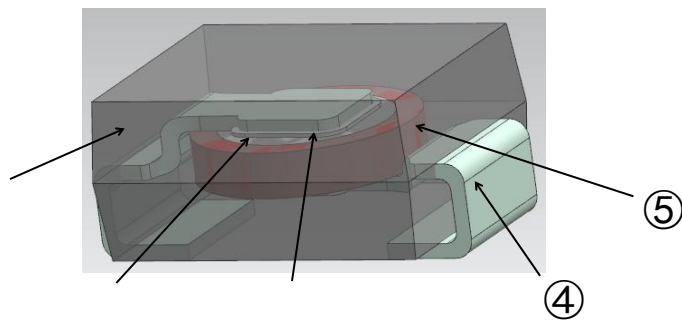

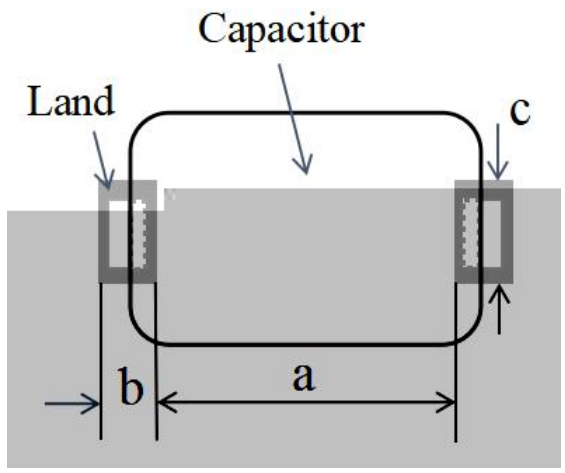

①			
②			
③			
④			
⑤			

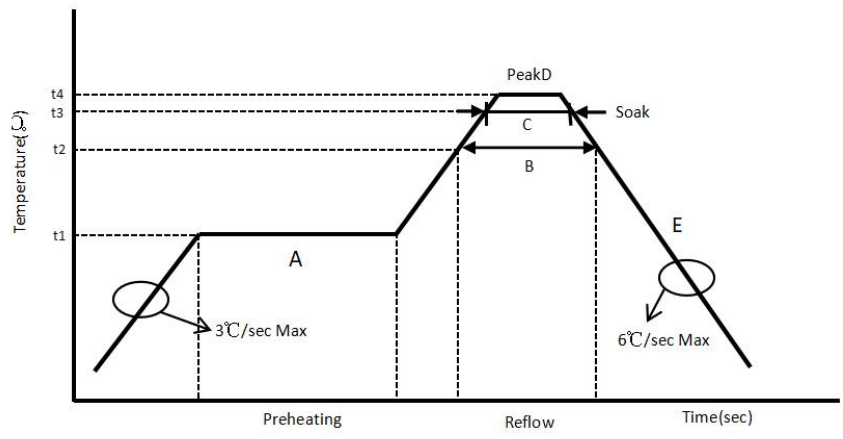

6. /  
/

°  
°C  
°  
°  
°



	- 2 2 . .		
	/		/
	/		/

/

°  
°C

°

°

°

/

7. /



	- 2 2 . .		
	/		/
	/		/



---



- 2  
2 ..

/

/

/

/

					±
		±			
		±			
		±			
		±			





			± ±
			± ± ±
			± ± ±
			± ± ±

8. /

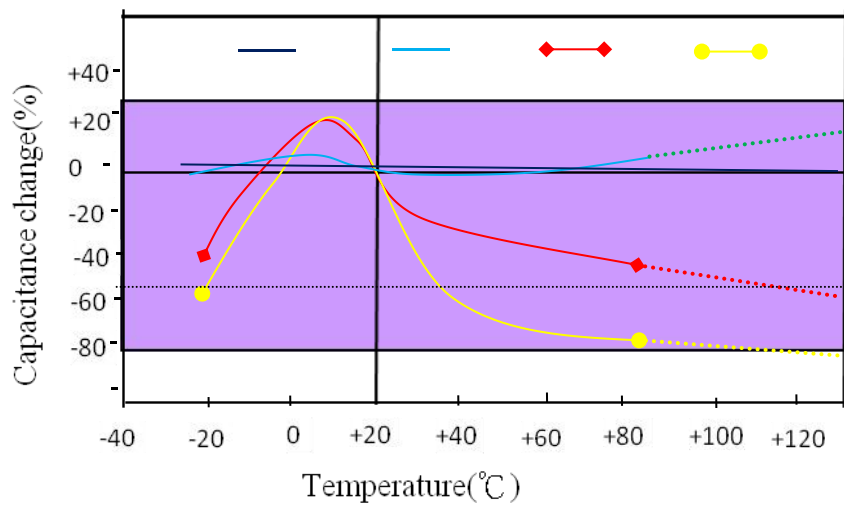



11. /  
/

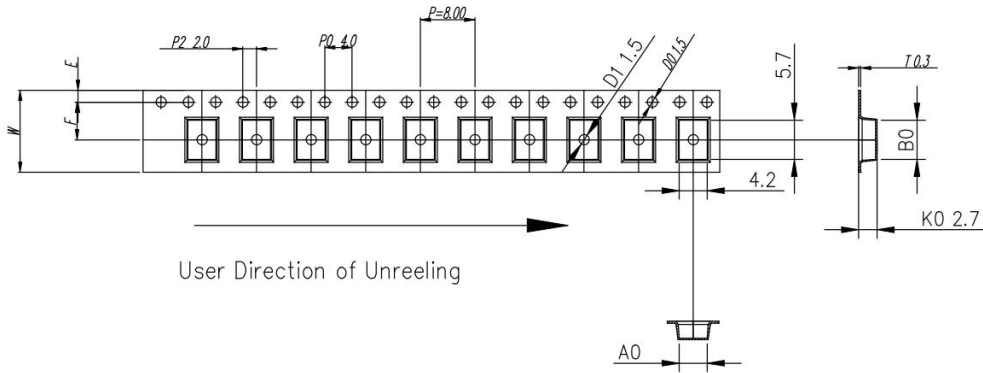

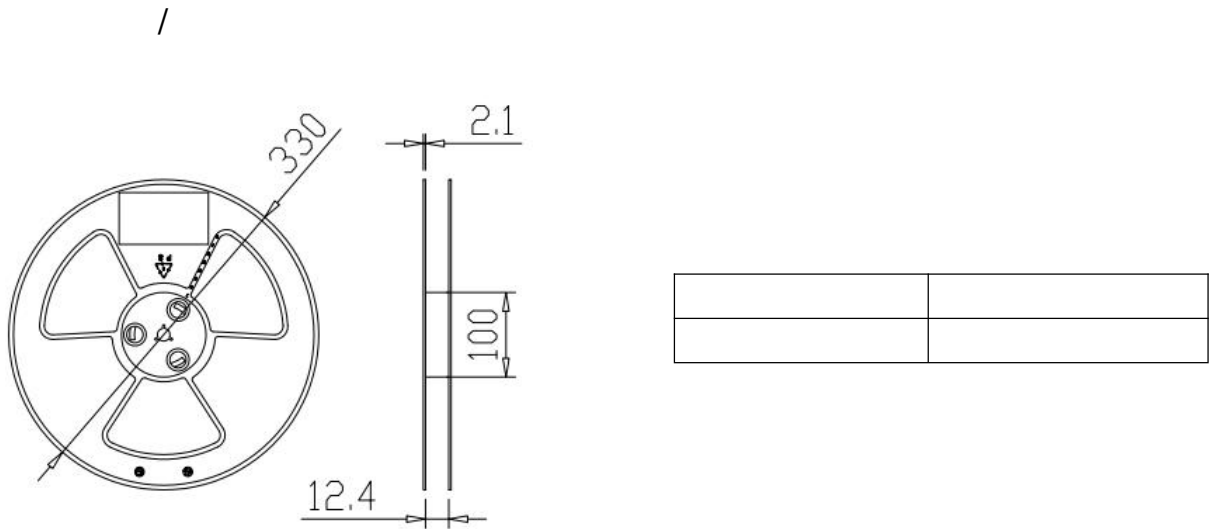

ITEM	W	A0	B0	K1	K0	P	F	E	D0	D1	P0	P2	T
DIM	12.0	$4.30^{+0.30}_{-0.30}$	$5.70^{+0.10}_{-0.10}$	--	$2.70^{+0.10}_{-0.10}$	8.00	$5.50^{+0.10}_{-0.10}$	1.75	$1.5^{+0.10}_{-0.10}$	$1.5^{+0.10}_{-0.10}$	4.0	2.0	$0.30^{+0.05}_{-0.05}$
ALTERNATE													



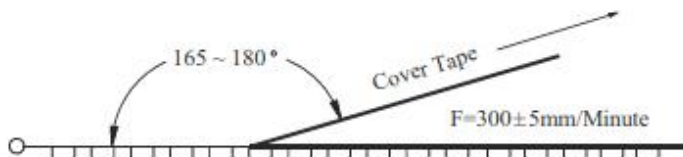

/

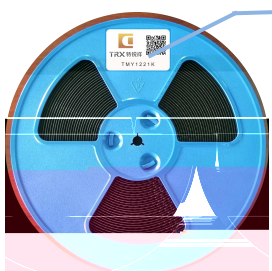
Item	Data	Remark
Cover tape adhesion	10 ~ 100g	Carrier tape and cover tape open angle 165 ~ 180° F=300±5mm/minute



/ -	 <p>标签</p>		 <p>料号</p>							

/ -										
			图示 /	图示 /	图示 /					

/ :										
	/	/								

" "



	- 2 2 . .		
	/		/
	/		/

12. /

①

②