

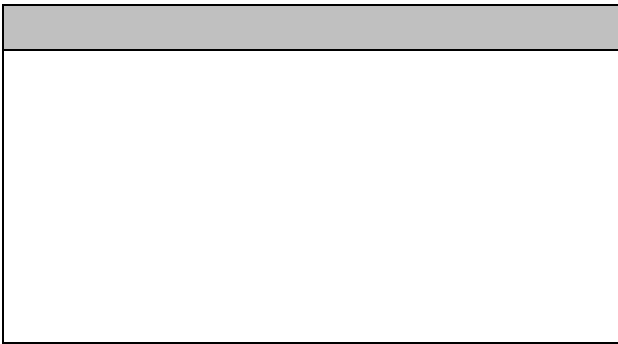

# MG100HF12TLC1

IGBT Modules

v





# MG100HF12TLC1



## Characteristic values

---

Parameter	Symbol	Conditions	Value	Unit
-----------	--------	------------	-------	------



# MG100HF12TLC1



## ● Diode

### Absolute Maximum Ratings

Parameter	Symbol	Conditions	Value	Unit

### Characteristic values

Parameter	Symbol	Conditions	Value			Unit
			Min.	Typ.	Max.	



# MG100HF12TLC1



## ● Module Characteristics

T<sub>c</sub>=25°C unless otherwise specified

Parameter	Symbol	Conditions	Value			Unit
			Min.	Typ.	Max.	
					0.19	
					0.29	



# MG100HF12TLC1

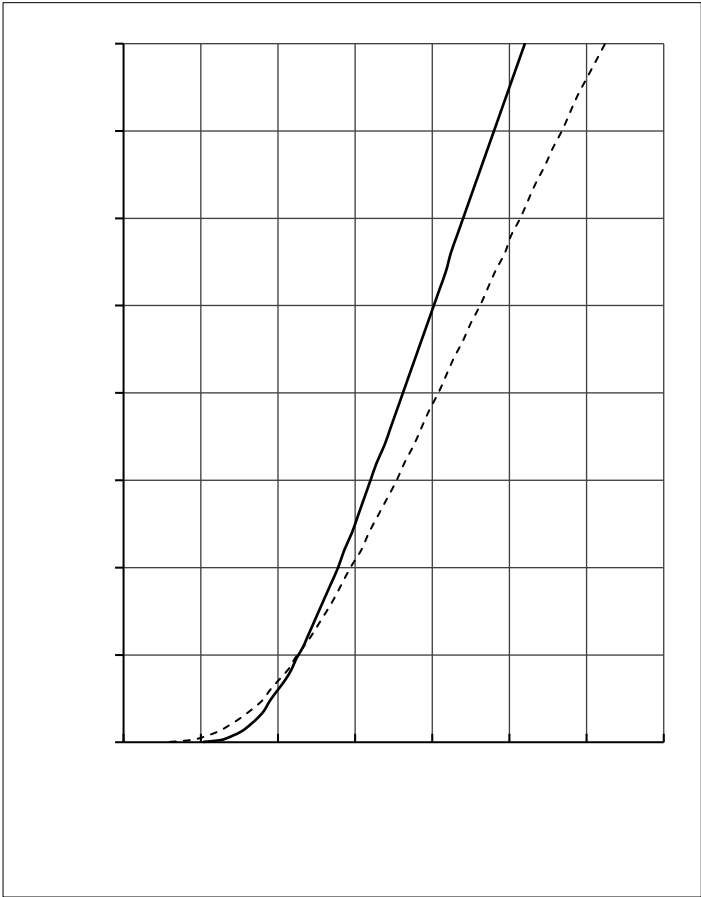



# MG100HF12TLC1

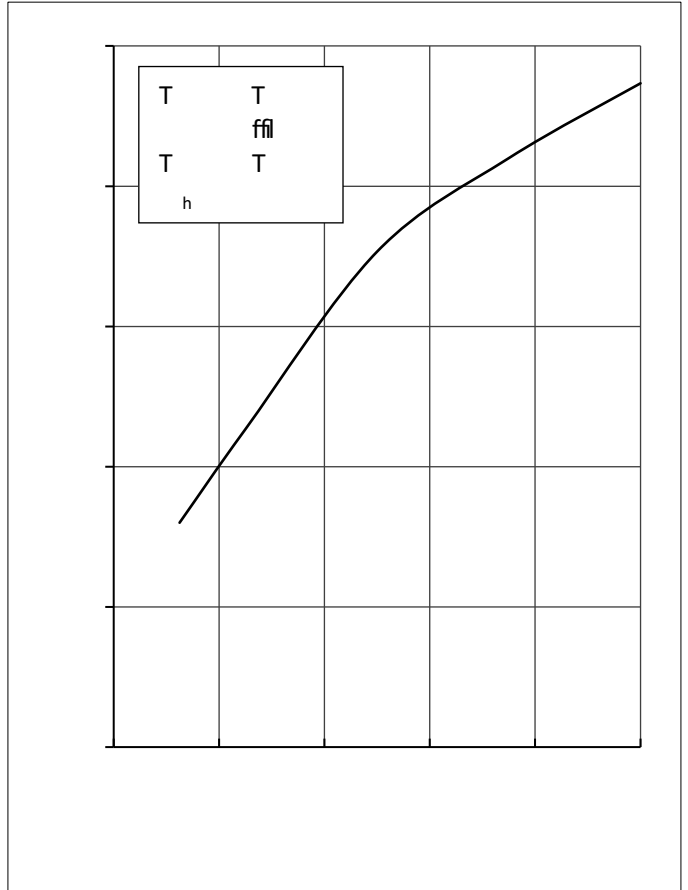
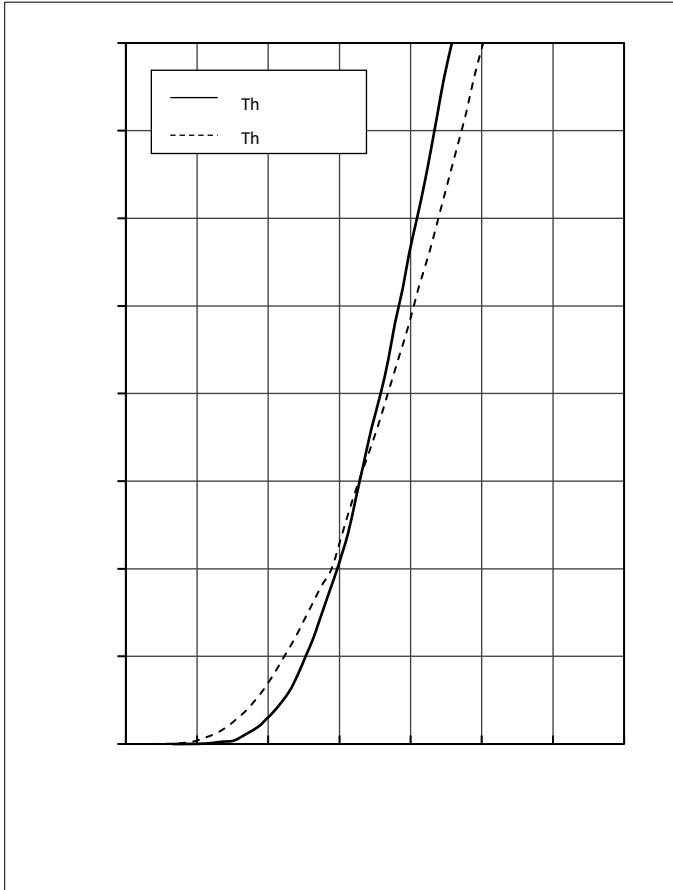
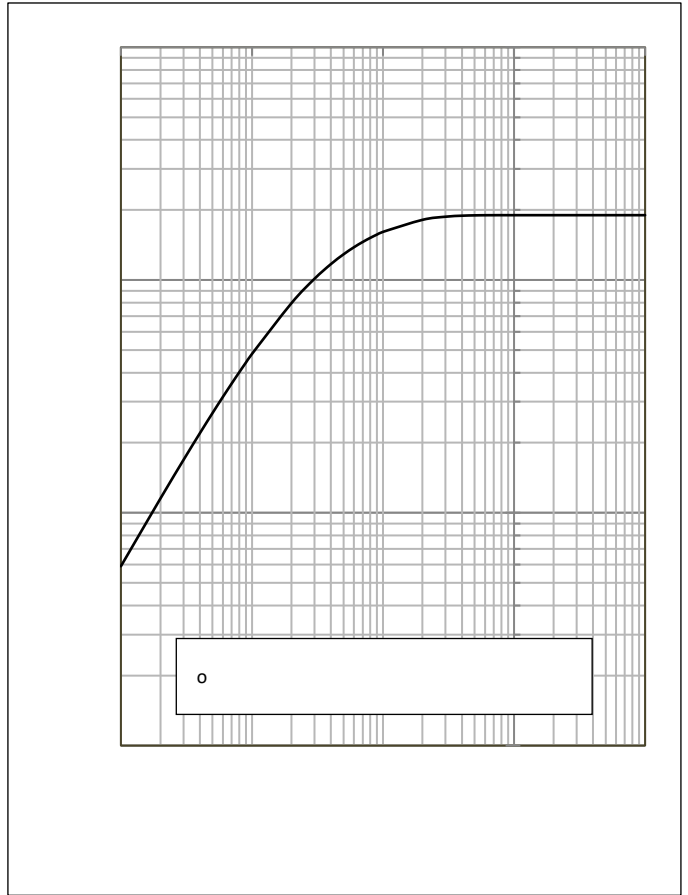
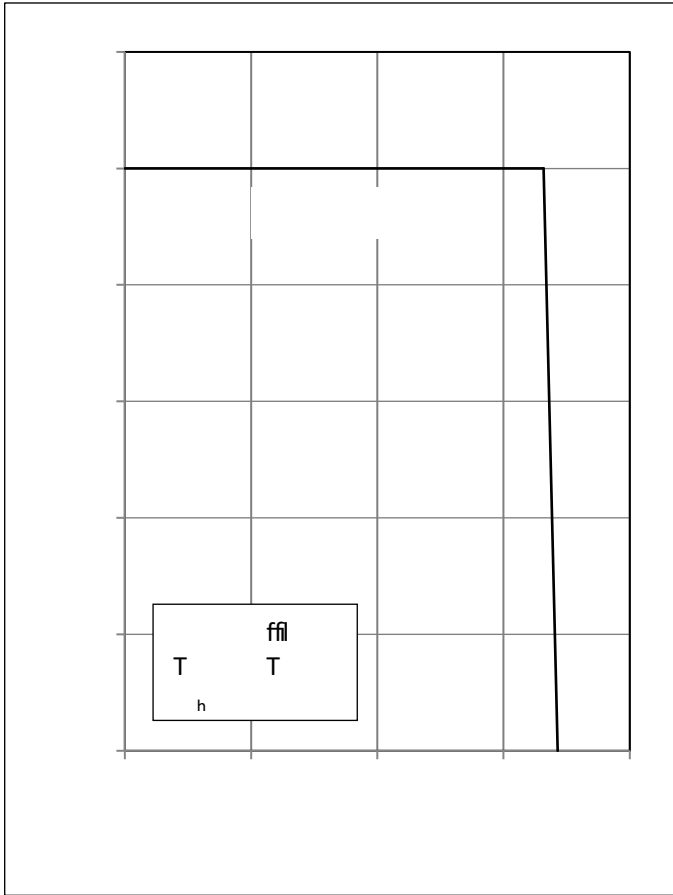



# MG100HF12TLC1

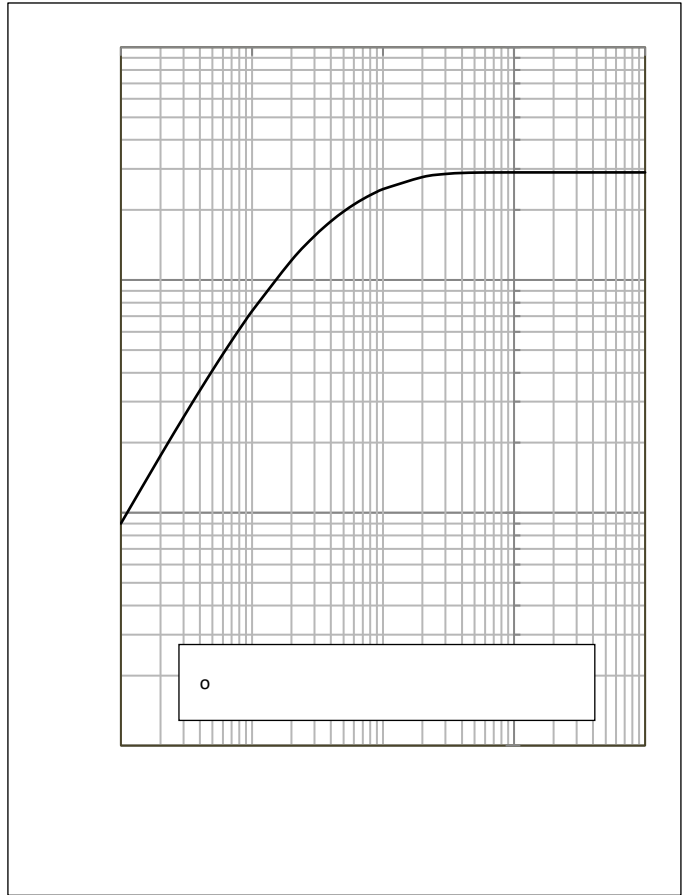
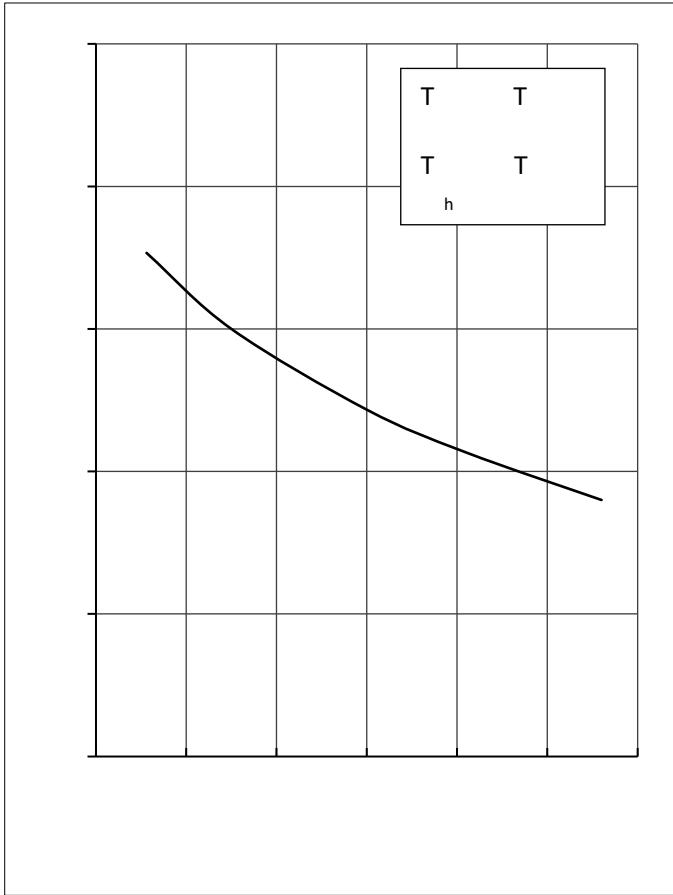



# MG100HF12TLC1

## ● Circuit Diagram

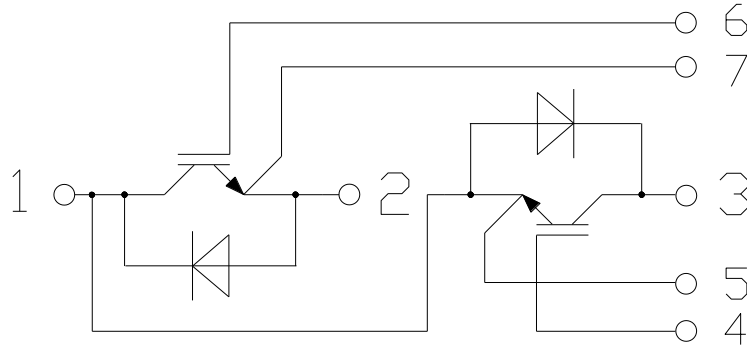

## ● Package Outline Information

