

深圳市弗瑞鑫电子有限公司

规格承认书

—

prepare	
check	
approve	



TRX电容一级代理商

深圳市弗瑞鑫电子有限公司

Add:深圳市宝安区西乡大道302号金源商务大厦B座3楼

Tel:0755-29563634

Fax:0755-27447020

	- 2 2 . .		
	/		/
	/		/

 TRX 专注电容器廿年	- 2 2 . .		
	/		/
	/		/

1. /

① ② ③ ④ ⑤ ⑥

①		
②		
③		
④		×
⑤		
⑥		±

2. /

	 TRX TL E 102M X1 440V~
--	---

	- 2 2 . .		
	/		/
	/		/

3. /



4. /

5. /

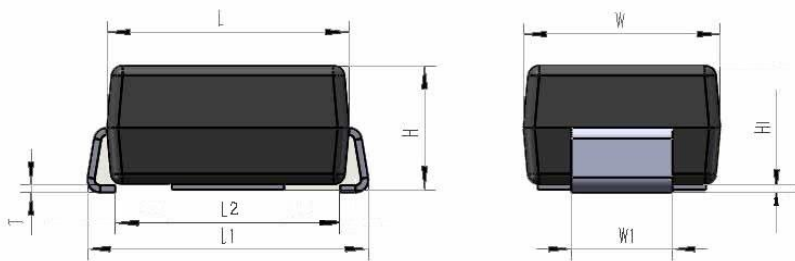



①		
②		
③		
④		
⑤		

- 2
2 ..

/

/

/

	- 2 2 . .		
	/		/
	/		/

/

°
°C

°

°

°

/

7. /

	- 2 2 . .		
	/		/
	/		/





- 2
2 ..

/

/

/

/

					±
		±			
		±			
		±			
		±			

			± ±
			± ± ±
			± ± ±

8. /

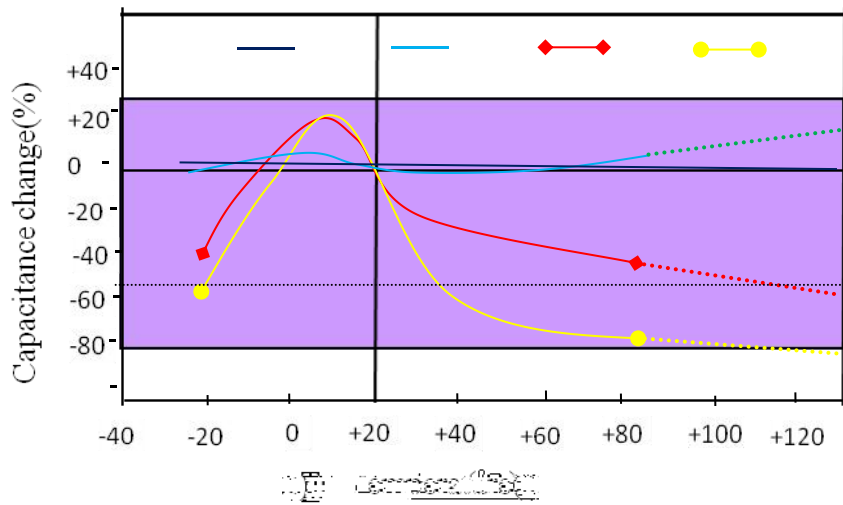

11. /
/

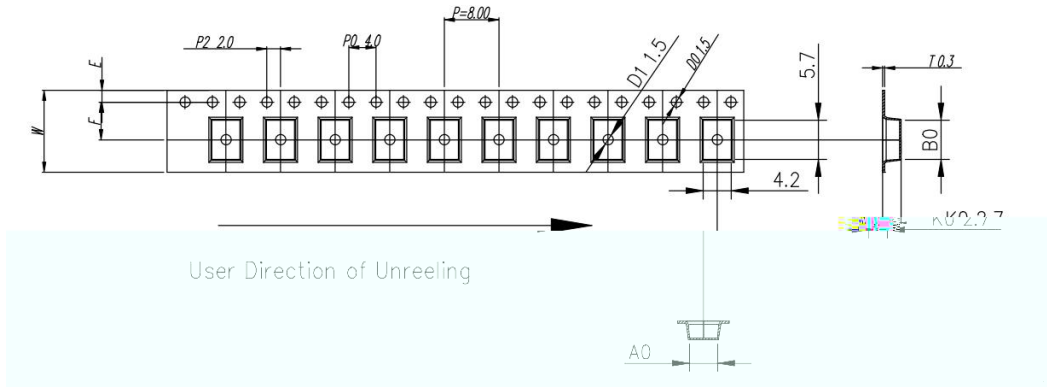

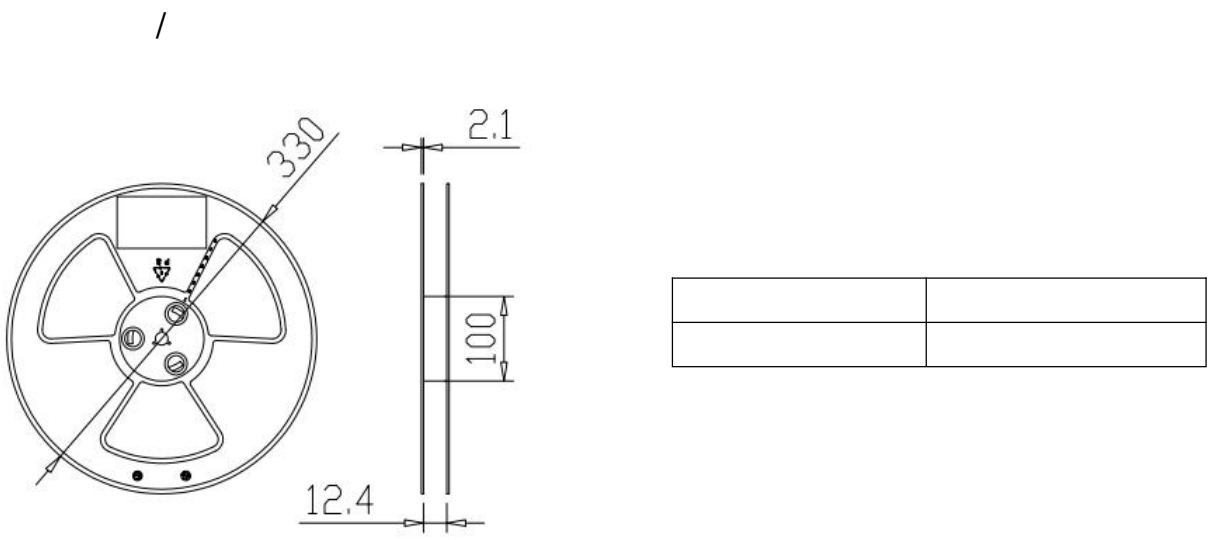

ITEM	W	A0	B0	K1	K0	P	F	E	D0	D1	P0	P2	T
DIM	12.0	$4.38^{+0.30/-0.30}$	$5.70^{+0.10/-0.10}$	--	$2.70^{+0.10/-0.10}$	8.00	$5.50^{+0.10/-0.10}$	1.75	$\phi 1.5^{+0.10/-0.10}$	$\phi 1.5^{+0.10/-0.10}$	4.0	2.0	0.30
ALTERNATE													

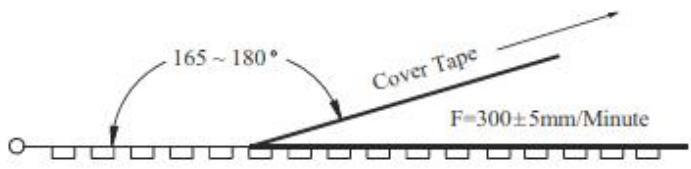

Item	Data	Remark
Cover tape adhesion	10 ~ 100g	Carrier tape and cover tape open angle 165 ~ 180° F=300±5mm/minute

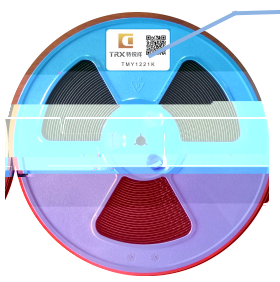

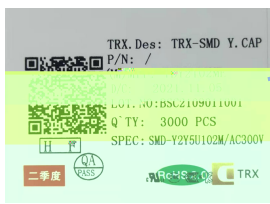
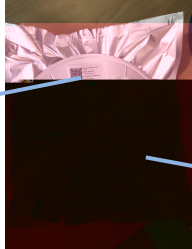
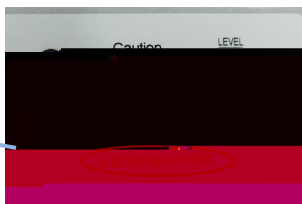
/ -	 <p>标签</p>  <p>料号</p>   		
-----	--	--	--

/ -	   	<p>图示 / 图示 / 图示 /</p> <table border="1"> <tr> <td></td> <td></td> <td></td> <td></td> </tr> <tr> <td></td> <td></td> <td></td> <td></td> </tr> </table>								

/ :	   
-----	--

" "

	- 2 2 . .		
	/		/
	/		/

12. /

①

②