

1200V
10A

Motor Drivers

AC and DC servo drive amplifier

UPS (Uninterruptible Power Supplies)

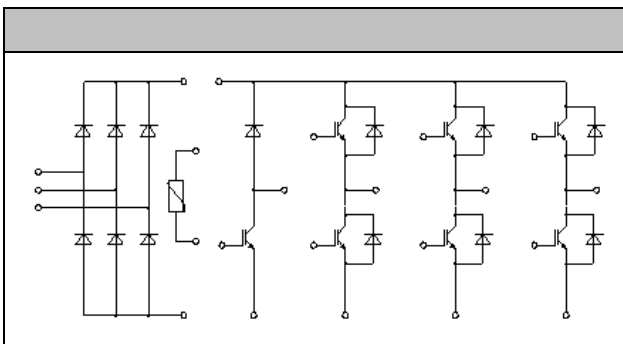

- Low switching losses
- Low $v_{ce(sat)}$ with positive temperature coefficient
- Including fast & soft recovery anti-parallel FWD
- Low inductance case
- High short circuit capability(10us)
- Isolated heatsink using DBC technology
- Maximum junction temperature 175

Collector-Emitter Voltage	V_{CES}	$V_{GE}=0V, I_C = 1mA, T_{vj}=25$	1200	V
Continuous Collector Current	I_C	$T_c=100, T_{vjmax}=175$	10	A
Repetitive Peak Collector Current	I_{CRM}	$tp=1ms$	20	A
Gate-Emitter Voltage	V_{GES}	$T_{vj}=25$	± 20	V
Total Power Dissipation	P_{tot}	$T_c=25$ $T_{vjmax}=175$	140	W



Gate-emitter Threshold Voltage	$V_{GE(th)}$	$V_{GE}=V_{CE}, I_C=0.5mA, T_{vj}=25$	5.2	6.0	6.6	V
Collector-Emitter Cut-off Current	I_{CES}	$V_{CE}=1200V, V_{GE}=0V, T_{vj}=25$			1.0	mA
Collector-Emitter Saturation Voltage	$V_{CE(sat)}$	$I_C=10A, V_{GE}=15V, T_{vj}=25$		1.85	2.20	V
		$I_C=10A, V_{GE}=15V, T_{vj}=125$		2.15		
		$I_C=10A, V_{GE}=15V, T_{vj}=150$		2.25		
Gate Charge	Q_G			0.13		uC
Input Capacitance	C_{ies}	$V_{CE}=25V, V_{GE}=0V,$		1.0		nF
Reverse Transfer Capacitance	C_{res}	$f=1MHz, T_{vj}=25$		0.03		nF
Gate-Emitter leakage current	I_{GES}	$V_{CE}=0V, V_{GE}=20V, T_{vj}=25$			400	nA
Turn-on Delay Time	$t_{d(on)}$	$I_C=10A$ $V_{CE}=600V$ $V_{GE}=\pm 15V$ $R_G=47$ $T_{vj}=25$		85		ns
Rise Time	t_r			50		ns
Turn-off Delay Time	$t_{d(off)}$			262		ns
Fall Time	t_f			140		ns
Energy Dissipation During Turn-on Time	E_{on}			0.98		mJ



Repetitive Peak Reverse Voltage	V_{RRM}	$T_{vj}=25$	1200	V
Continuous DC Forward Current	I_F		10	A
Repetitive Peak Forward Current	I_{FRM}	$t_p=1ms$	20	A
I^2t -value	I^2t	$V_R=0, t_p=10ms, T_{vj}=125$	16.0	A^2s
		$V_R=0, t_p=10ms, T_{vj}=150$	14.0	

Forward Voltage	V_F	$I_F=10A, T_{vj}=25$		2.0	2.5	V
		$I_F=10A, T_{vj}=125$		2.1		
		$I_F=10A, T_{vj}=150$		2.1		
Recovered Charge	Q_{rr}	$I_F =10 A$		0.90		μC
Peak Reverse Recovery Current	I_{rr}	$V_R=600V$ $-di_F/dt =500A/\mu s$		12.5		A
Reverse Recovery Energy	E_{rec}	$T_{vj}=25$		0.25		mJ
Recovered Charge	Q_{rr}	$I_F =10 A$		1.70		μC
Peak Reverse Recovery Current	I_{rr}	$V_R=600V$ $-di_F/dt =500A/\mu s$		10.4		A
Reverse Recovery Energy	E_{rec}	$T_{vj}=125$		0.50		mJ



Collector-Emitter Voltage	V_{CES}	$V_{GE}=0V, I_C=1mA, T_{vj}=25$	1200	V
Continuous Collector Current	I_C	$T_c=100, T_{vjmax}=175$	10	A
Repetitive Peak Collector Current	I_{CRM}	$tp=1ms$	20	A
Gate-Emitter Voltage	V_{GES}	$T_{vj}=25$	± 20	V
Total Power Dissipation	P_{tot}	$T_c=25, T_{vjmax}=175$	105	W



Turn-on Delay Time	$t_{d(on)}$	$I_C = 10A$ $V_{CE} = 600V$ $V_{GE} = \pm 15V$ $R_G = 47$ $T_{vj} = 125$		90		ns
Rise Time	t_r			60		ns
Turn-off Delay Time	$t_{d(off)}$			285		ns
Fall Time	t_f			150		ns
Energy Dissipation During Turn-on Time	E_{on}			1.33		mJ
Energy Dissipation During Turn-off Time	E_{off}			0.9		mJ
SC Data	I_{sc}	$T_p = 10\mu s, V_{GE} = 15V, T_{vj} = 150$, $V_{cc} = 900V, V_{CEM} = 1200V$		70		A

Repetitive Peak Reverse Voltage	V_{RRM}	$T_j = 25$		1200		V
Continuous DC Forward Current	I_F			10		A
Repetitive Peak Forward Current	I_{FRM}	$tp = 1ms$		20		A
I^2t -value	I^2t	$V_R = 0, t_p = 10ms, T_j = 125$		16.0		A ² s
		$V_R = 0, t_p = 10ms, T_j = 150$		14.0		

Forward Voltage	V_F	$I_F = 10A, T_{vj} = 25$		2.0	2.5	V
		$I_F = 10A, T_{vj} = 125$		2.1		
		$I_F = 10A, T_{vj} = 150$		2.1		
Recovered Charge	Q_{rr}	$I_F = 10A$		0.90		μC
Peak Reverse Recovery Current	I_{rr}	$V_R = 600V$ $-di_F/dt = 500A/\mu s$		12.5		A
Reverse Recovery Energy	E_{rec}	$T_{vj} = 25$		0.25		mJ
Recovered Charge	Q_{rr}	$I_F = 10A$		1.70		μC
Peak Reverse Recovery Current	I_{rr}	$V_R = 600V$ $-di_F/dt = 500A/\mu s$		10.4		A
Reverse Recovery Energy	E_{rec}	$T_{vj} = 125$		0.50		mJ



Repetitive Peak Reverse Voltage	V_{RRM}	$T_j=25$	1600	V
Average output Current 50/60Hz, sine wave	$I_{F(AV)}$	$T_c=100$	10	A
Maximum RMS Current at Rectifier Output	I_{RMSM}	$T_c=100$	10	A
Surge Forward Current	I_{FSM}	$V_R=0, t_p=10ms, T_j=45$	150	A
I^2t -value	I^2t	$V_R=0, t_p=10ms, T_j=45$	110	A ² s

Diode Forward Voltage	V_F	$I_F=10A, T_j=150$	1.00	V
Reverse Current	I_R	$T_j=150, V_R=1600V$	1.0	mA

Rated Resistance	R_{25}		5.0	k	
Deviation of R100	R/R	$T_c=100, R_{100}=493.3$	-5	5	%
Power Dissipation	P_{25}			20.0	mW
B-value	$B_{25/50}$	$R_2=R_{25}\exp[B_{25/50}(1/T_2-1/(298.15K))]$		3375	K



MG10P12P2

RoHS
COMPLIANT

($T_C=25^{\circ}\text{C}$ unless otherwise specified)

--	--	--	--	--

W

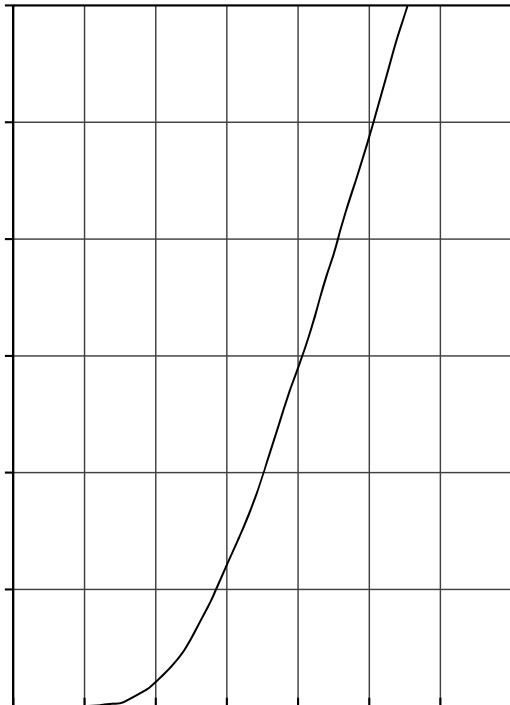
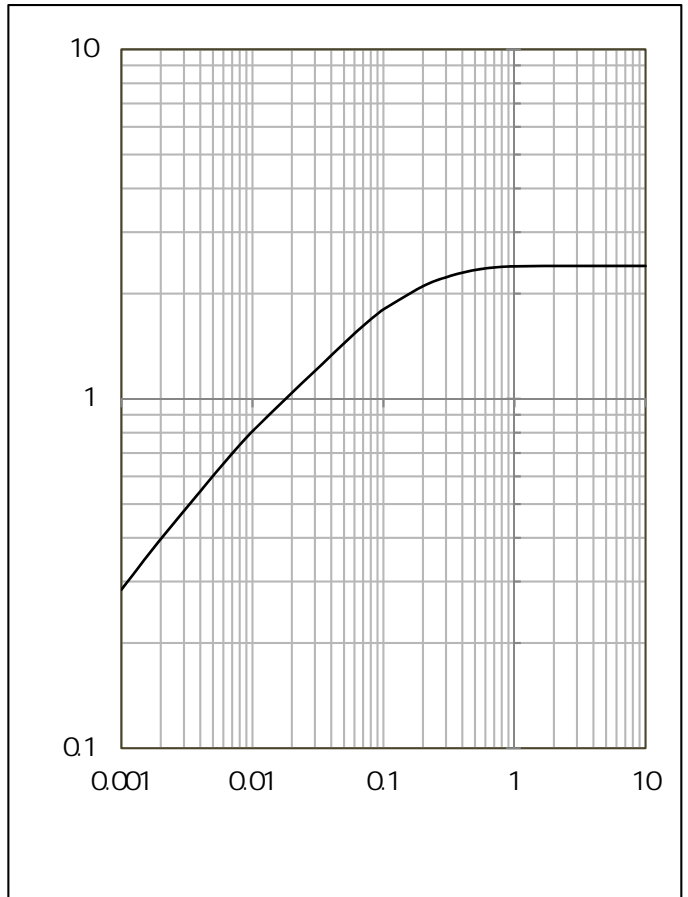
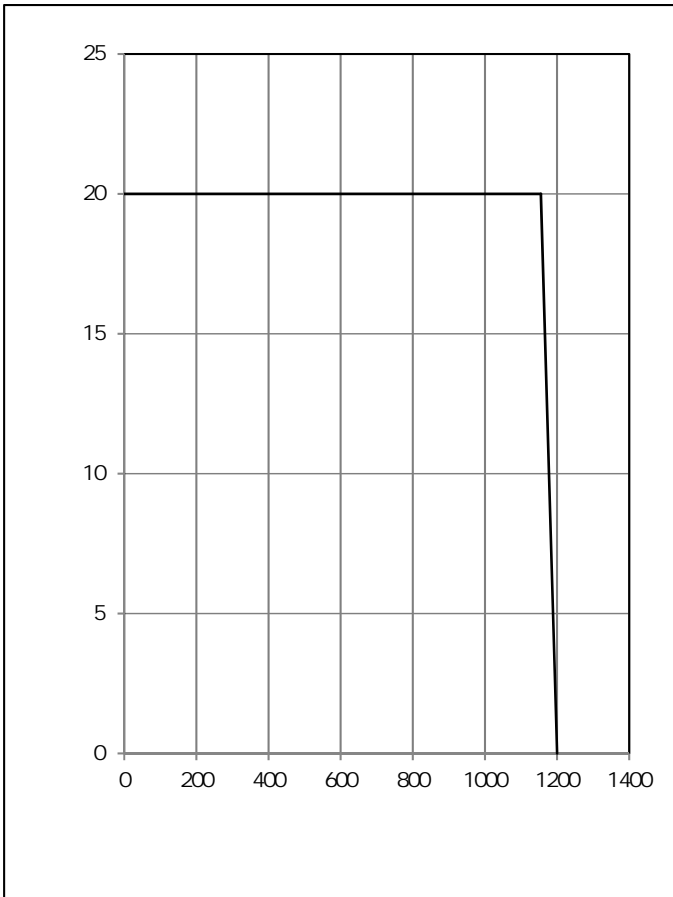

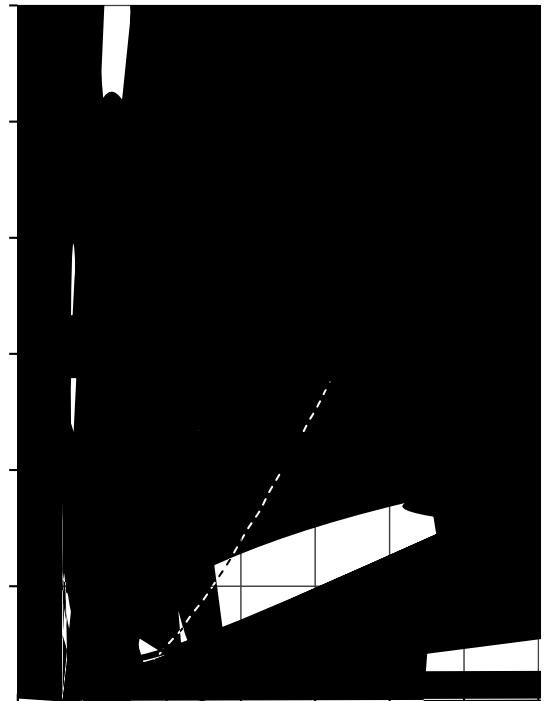
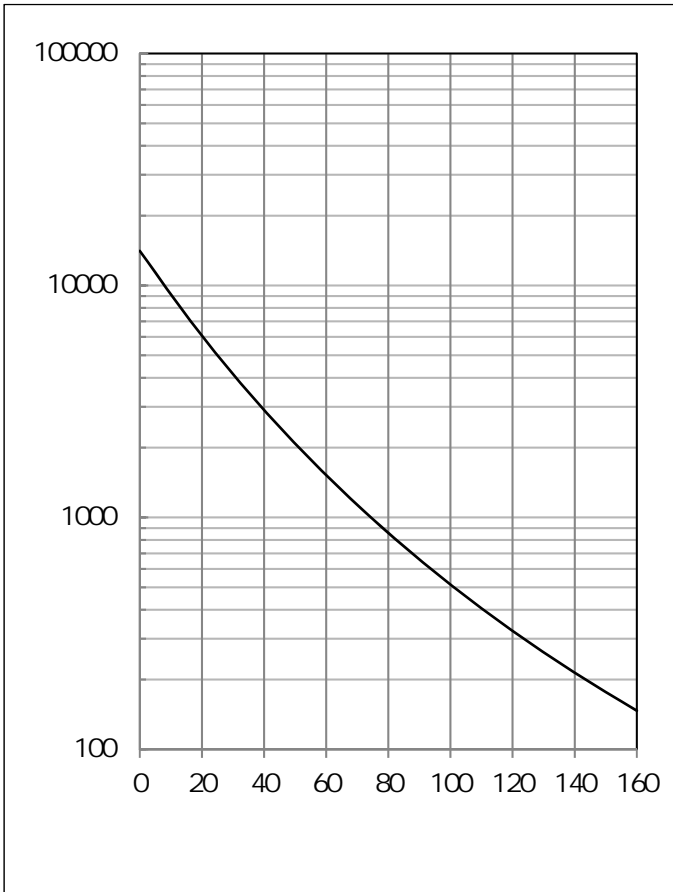
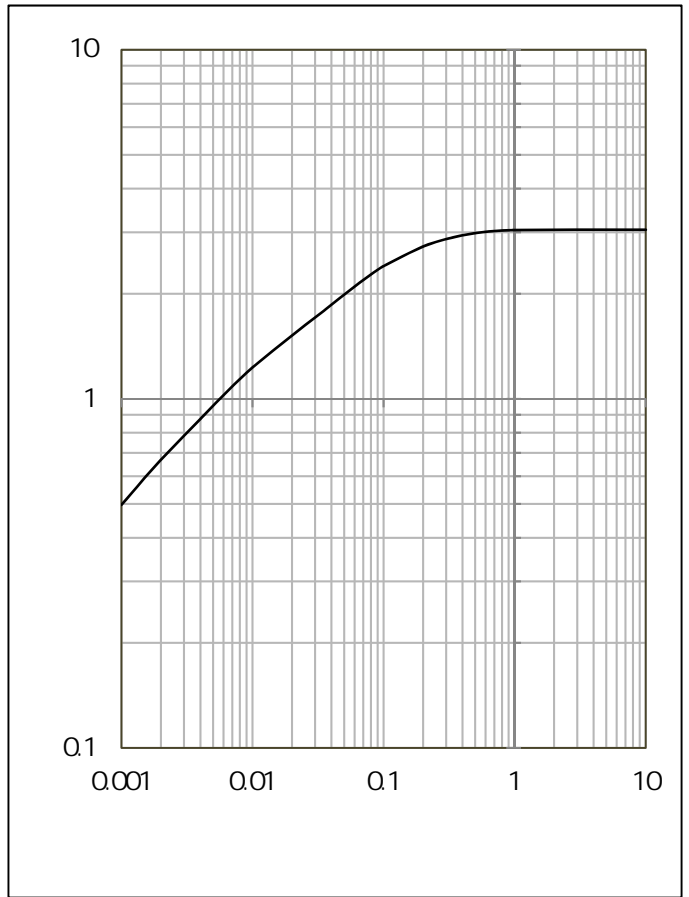
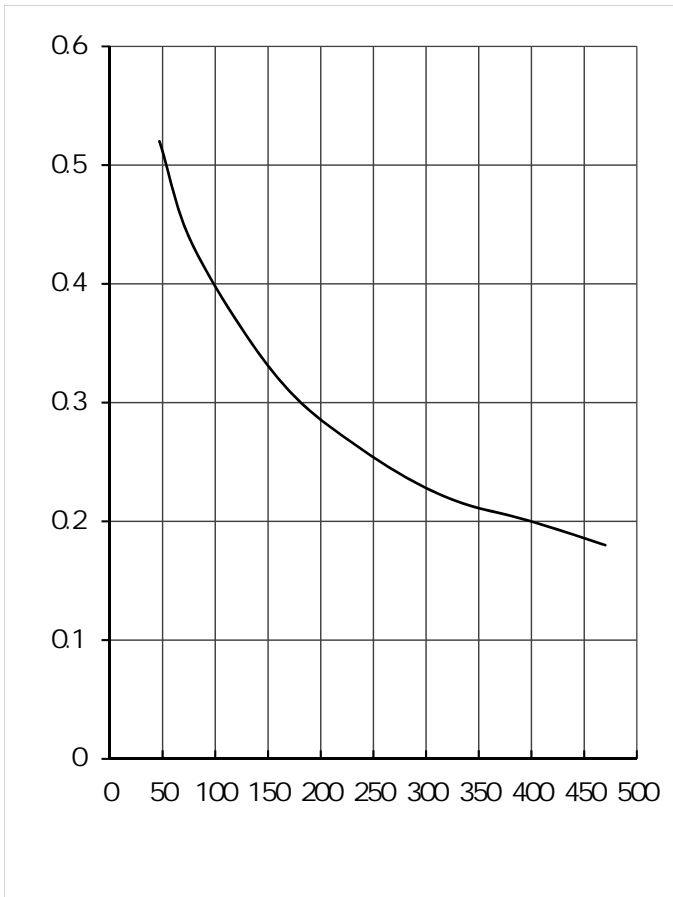

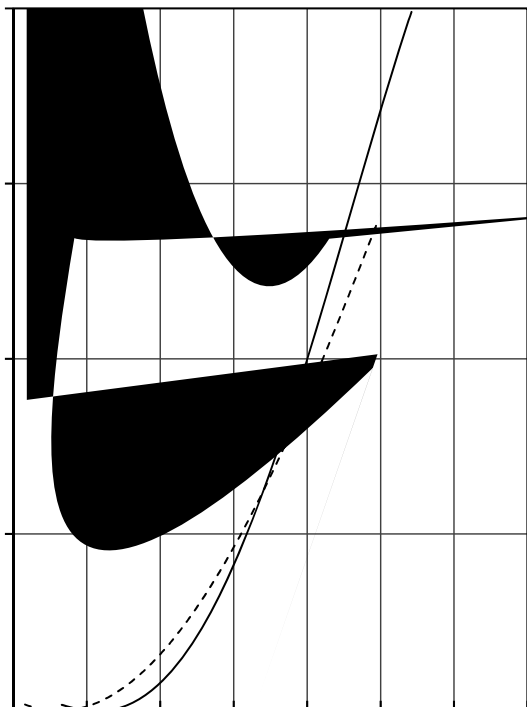



MG10P12P2

RoHS
COMPLIANT

