

# 深圳市弗瑞鑫电子有限公司

## 规格承认书

—  
————  
————

prepare	
check	
approve	



TRX电容一级代理商

深圳市弗瑞鑫电子有限公司

Add:深圳市宝安区西乡大道302号金源商务大厦B座3楼

Tel:0755-29563634

Fax:0755-27447020

- 2

2 . .

/

/

/

/

	- 2 2 . .		
	/		/
	/		/

	- 2 2 . .		
	/		/
	/		/

1. /

$\overline{\text{①}}$   $\overline{\text{②}}$   $\overline{\text{③}}$   $\overline{\text{④}}$   $\overline{\text{⑤}}$   $\overline{\text{⑥}}$

①

	- 2 2 . .		
	/		/
	/		/

3. /



4. /

5. /





①		
②		
③		
④		
⑤		

- 2  
2 ..

/

/

/

	- 2 2 . .		
	/		/
	/		/

/

°  
°C

°

°

°

/

7. /



	- 2 2 . .		
	/		/
	/		/





- 2  
2 ..

/

/

/

/

					±
		±			
		±			
		±			
		±			



**TRX**  
 专注电容器廿年

- 2  
 2 . .

/

/

/

/

--	--	--	--

		±	
--	--	---	--

		△ △ △ △ △	

		△ △ △ △ △	

/

/

/

/

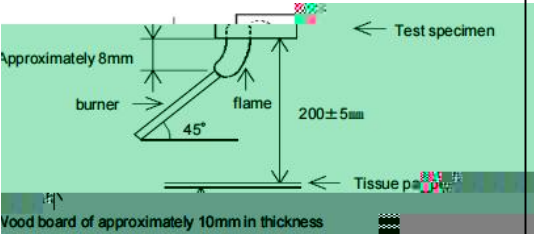
			 <p>Approximately 8mm</p> <p>burner</p> <p>45°</p> <p>flame</p> <p>200 ± 5mm</p> <p>Test specimen</p> <p>Tissue paper</p> <p>Wood board of approximately 10mm in thickness</p>

			± ±
			± ± ±
			± ± ±

8. /

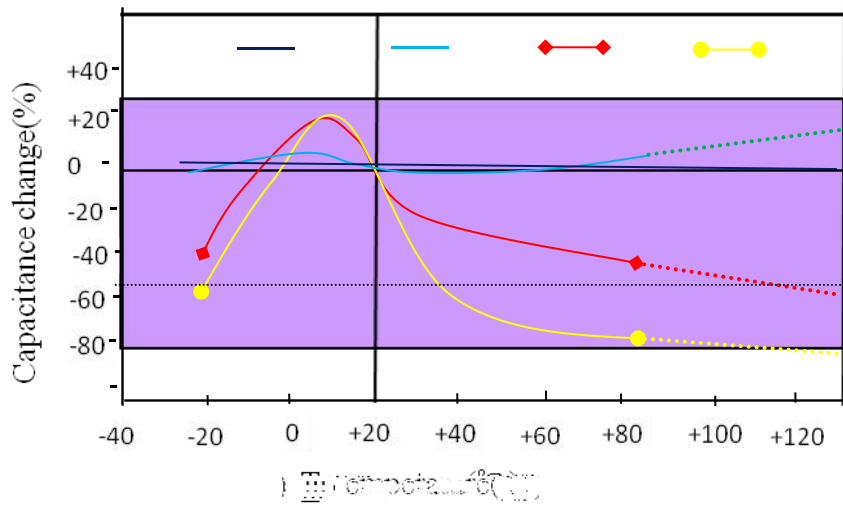



11. /  
/

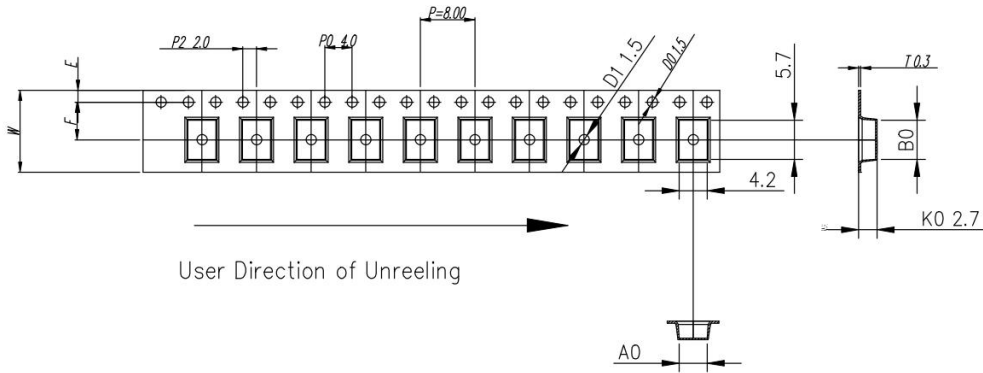

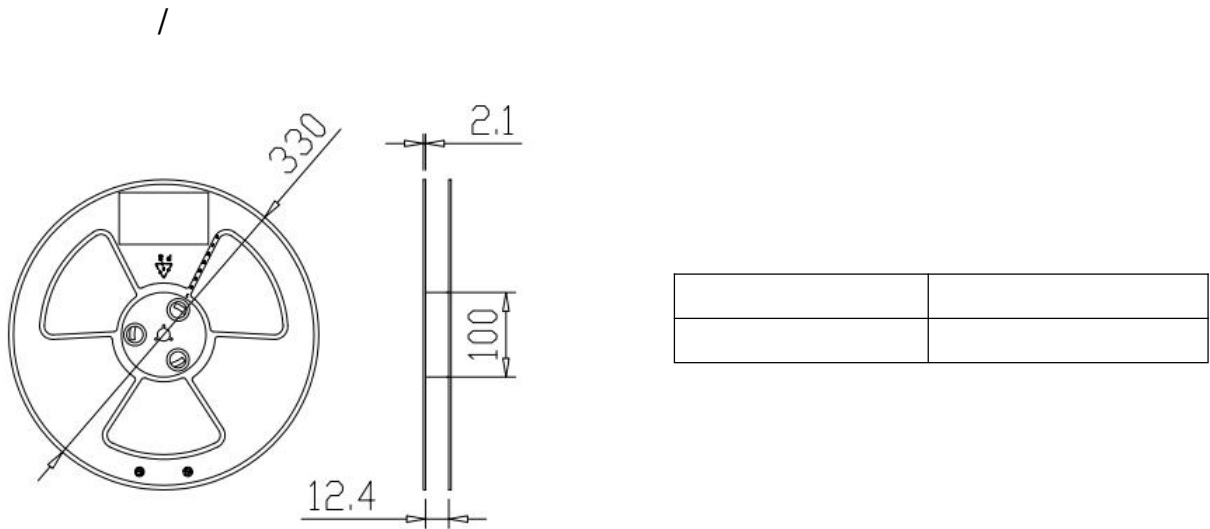

ITEM	W	A0	B0	K1	K0	P	F	E	D0	D1	P0	P2	T
DIM	12.0	$4.0 \pm 0.30$	$5.70 \pm 0.10$	--	$2.70 \pm 0.10$	$8.00 \pm 0.10$	$5.50 \pm 0.10$	$1.75 \pm 0.10$	$\phi 1.5 \pm 0.05$	$\phi 1.5 \pm 0.10$	$4.0 \pm 0.10$	$2.0 \pm 0.10$	$0.30 \pm 0.05$
ALTERNATE													





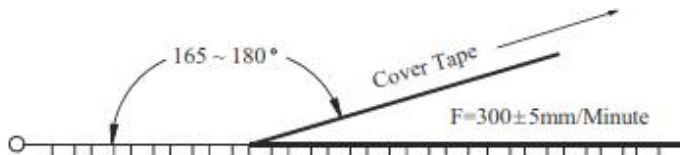

/

Item	Data	Remark
Cover tape adhesion	10 ~ 100g	Carrier tape and cover tape open angle 165 ~ 180° F=300±5mm/minute

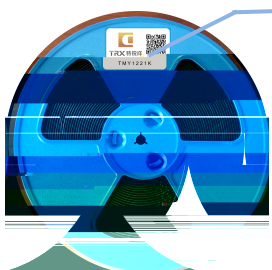

 <b>TRX</b> 专注电容器廿年	- 2 2 . .		
	/		/
	/		/

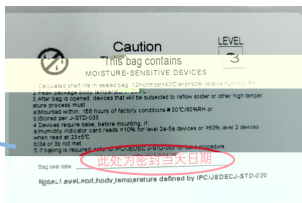
/ -	 <p>标签</p>	 <p>料号</p>		
				

/ -				
	图示 /	图示 /	图示 /	

/ :				
	/	/		

" "



